

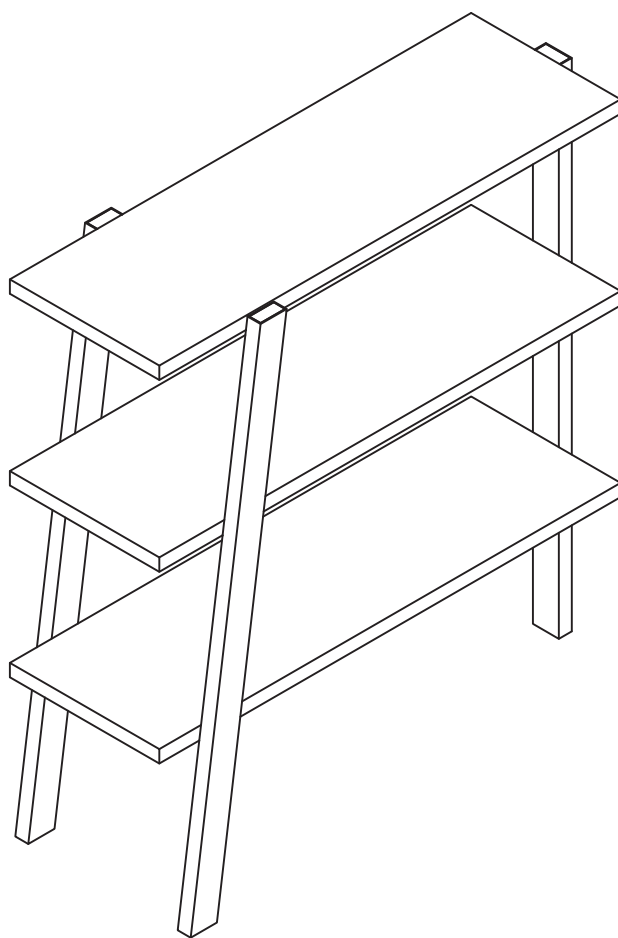









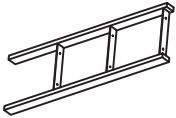

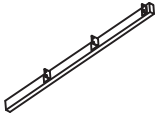

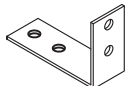
Mirella Series  
3 Shelf Bookshelf  
Model No. MRBS3

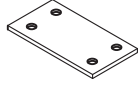
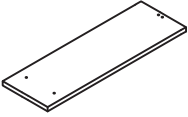

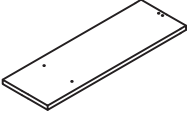
For questions or concerns, please call 1-888-971-6225 available  
Monday-Friday 7:30 AM to 5:00 PM (Central Time)  
(English-speaking operators)

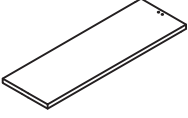
# PARTS LIST

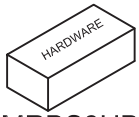
Name	Part	Qty.	Spare Qty	Name	Part	Qty.	Spare Qty
A	 Metal Frame	1		H	 M6*15mm	2	1
B	 Metal Frame	1		I	 4mm Wrench	1	
C	 100*70*38*4mm	1		J	 Plastic Mat	3	
D	 60*38*4mm	1		K	 Bottom Fixed Shelf	1	
E	 M4*20mm	6	1	L	 Top Panel	1	
F	 M6*15mm	8	1	M	 Middle Fixed Shelf	1	
G	 M4.2*16mm	4	1		 MRBS3HB		

Items with HB are in hardware box.

## IMPORTANT!

**Review ALL instructions before beginning assembly.** These instructions are provided to avoid problems that may occur from improper assembly or installation. SAFCO and/or its distributor are not responsible for failure resulting from improper assembly or installation of this product. Moreover, all warranties are void for failure to follow these assembly instructions.

- 1 Use the Screw (E&F) to install the Top Panel (L) and Fixed Shelf (K&M) on the Metal Frame (A&B). Adhere the Plastic Mat (J) on the bottom of the Metal Legs (A&B);

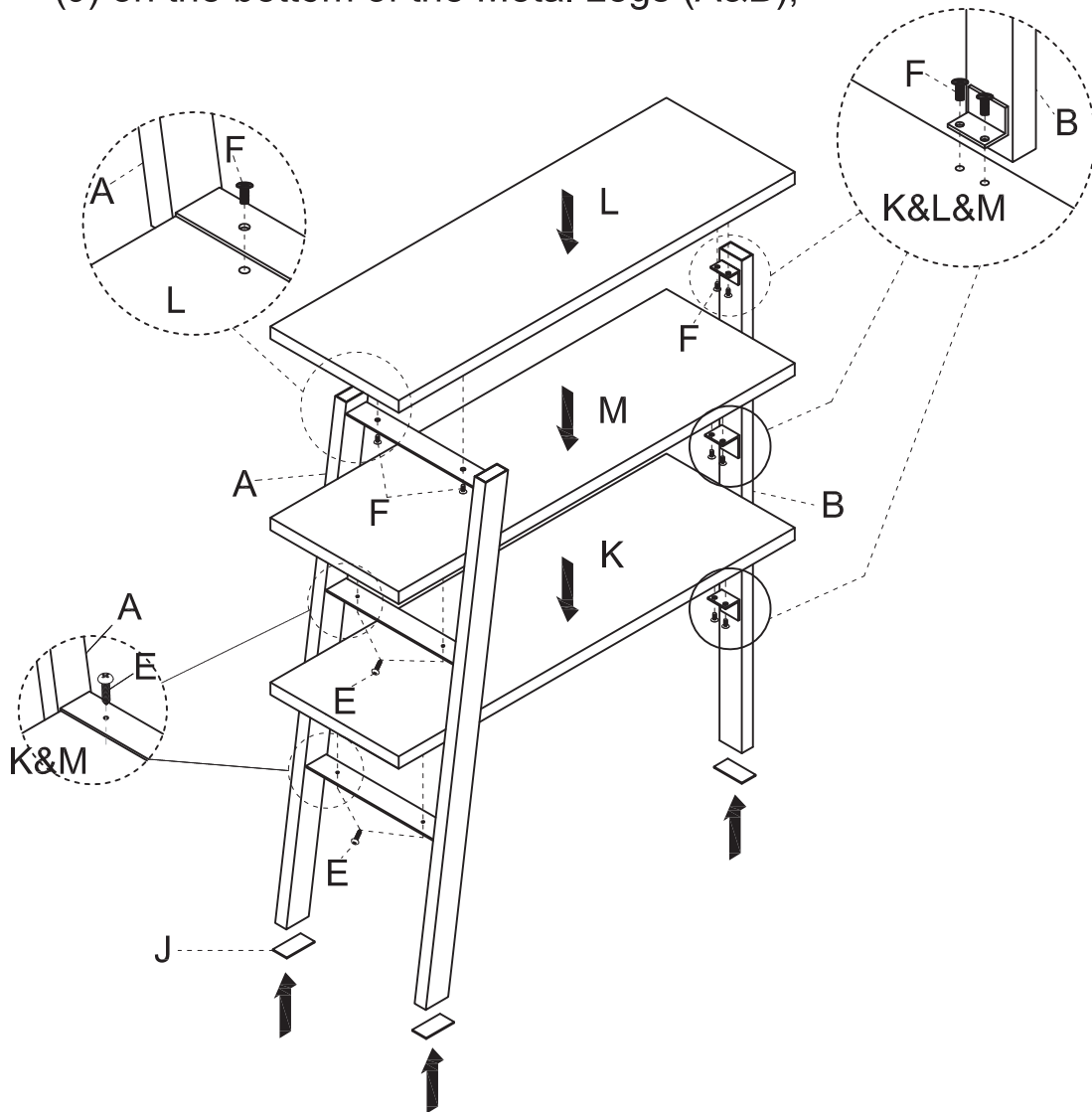

- 2** Use the Screw (E&H&G) and Metal Brackets (C&D) to install the 3-shelf bookcase on MRLFC36 or MRSC36.

